

# SUCTION CUPS / Oval Universal

## VOU4x20

### Features and Strengths

Great performance for handling long objects with flat and curved surfaces

### Examples of use

Semiconductor Chips, PCB boards, Electronic component  
Solar cell, Small glass cases, Pipes



### Recommended Lifting Force (Max.)

Model	Volume (cm <sup>3</sup> )	Min. Curvature Radius R(mm)	Lifting Force (Kg) - Perpendicular		
			- 20 kPa	- 60 kPa	- 90 kPa
VOU4x20	0.094	3.50	0.24	0.48	0.60

※ The lifting force above does not include safety factor

### Material Specifications

Material	Hardness Shore (°)	Color	Temperature (°C)
NBR	60	Black	-20~110
Silicone	55	Red	-70~200
White Silicone	55	Translucent White	-70~200
White Silicone (FDA)	55	Translucent White	-70~200
High temp. Silicone	50	Blue	-70~280
Conductive Silicone	70	Smoky Black	-45~90
Urethane	60	Dark Green	0~100

### Material Resistance

Description	NBR	Silicone	White Silicone	High temp. Silicone	Conductive Silicone	Urethane
Wear Resistance	Excellent	Good	Good	Good	Good	Excellent
Oil	Excellent	Poor	Poor	Poor	Poor	Excellent
Weather / Ozone	Fair	Excellent	Excellent	Excellent	Excellent	Excellent
Alcohol	Good	Good	Good	Good	Good	Fair
Acid	Fair	Poor	Poor	Poor	Poor	Poor

### Dimension

[ Unit : mm ]

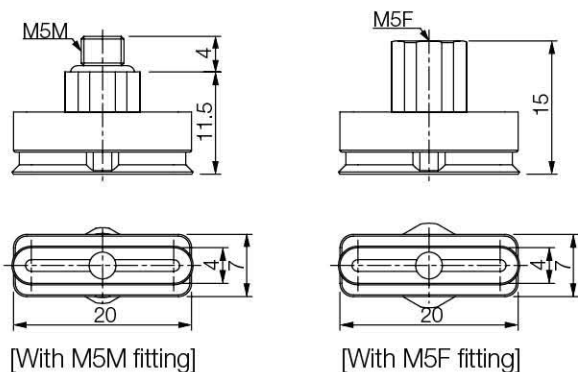

## Build an Ordering No.

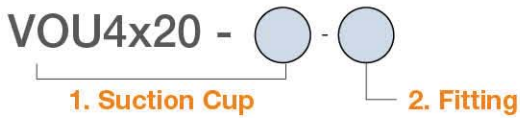

1. Suction cup	Description	Symbol
	Oval-Universal suction cup, 4x20mm diameter, Nitrile (NBR)	VOU4x20-N
	Oval-Universal suction cup, 4x20mm diameter, Silicone	VOU4x20-S
	Oval-Universal suction cup, 4x20mm diameter, White silicone	VOU4x20-WS
	Oval-Universal suction cup, 4x20mm diameter, White silicone (FDA)	VOU4x20-WS (FDA)
	Oval-Universal suction cup, 4x20mm diameter, High temperature silicone	VOU4x20-HS
	Oval-Universal suction cup, 4x20mm diameter, Conductive silicone	VOU4x20-CS
	Oval-Universal suction cup, 4x20mm diameter, Urethane	VOU4x20-U
2. Fitting	Description	Symbol
	Fitting, M5 female	M5F
	Fitting, M5 male	M5M

## Spare Parts – Rubber Parts

Part No.	Description	Weight (g)	Color
VOU4x20-N	Oval-Universal suction cup, 4x20mm diameter, Nitrile (NBR)	0.72	Black
VOU4x20-S	Oval-Universal suction cup, 4x20mm diameter, Silicone	0.61	Red
VOU4x20-WS	Oval-Universal suction cup, 4x20mm diameter, White silicone	0.60	Translucent White
VOU4x20-WS (FDA)	Oval-Universal suction cup, 4x20mm diameter, White silicone (FDA)	0.60	Translucent White
VOU4x20-HS	Oval-Universal suction cup, 4x20mm diameter, High temperature silicone	0.74	Blue
VOU4x20-CS	Oval-Universal suction cup, 4x20mm diameter, Conductive silicone	0.7	Smoky Black
VOU4x20-U	Oval-Universal suction cup, 4x20mm diameter, Urethane	0.74	Dark Green

## Dimension

[ Unit : mm ]

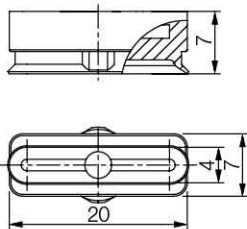

[Rubber part]

## Spare Parts – Fittings

Part No. (Code No.)	Fitting size	Description	Weight (g)
350 002 1112	M5F	M5 female	2.82
350 002 1012	M5M	M5 male	1.78