

**Technical details**

<b>Connection</b>	G1/4, Namur
<b>Nominal size</b>	6 mm
<b>Temperature range</b>	-30°C ... +80°C
<b>Medium</b>	Filtered, oil-free and dried compressed air according to ISO 8573-1:2010, Class 7:2:4, instrument air, free of aggressive additives. Alternatively the pressure dew point must be at least 10°C below lowest occurring ambient temperature.
<b>Materials</b>	Body: Al (anodized), seals: FKM , inner parts: Al, stainless steel and brass
<b>Protection</b>	IP 65 according to EN 60529



Electrically operated spool valve. The manual override is detent and is operated by screw driver. The location pin, screws and seals are included.

**3/2-way-valves**

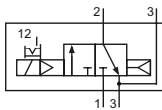

ICKN-55-310-HN-xxx  
3/2-way, single solenoid, air spring return, NC

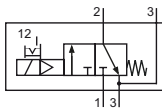

ICKN-55-311-HN-xxx  
3/2-way, single solenoid, mechanical spring return, NC

**5/2- and 5/3-way-valves**

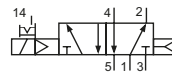

ICKN-55-510-HN-xxx  
5/2-way, single solenoid, air spring return

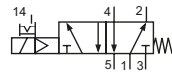

ICKN-55-511-HN-xxx  
5/2-way, single solenoid, mechanical spring return

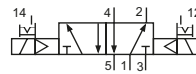

ICKN-55-520-HN-xxx  
5/2-way, double solenoid

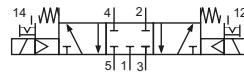

ICKN-55-530-HN-xxx  
5/3-way, center position closed

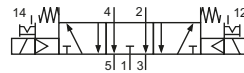

ICKN-55-533-HN-xxx  
5/3-way, center position exhausted

Please complete: xxx = electrical option

**Electrical options**

Nominal Ivoltage	Power consumption	Specifics	Plug connection*1	-xxx
24 V DC	4.2 W		Form B industrial norm	-F42

\*1 Plug socket not included, suitable plug sockets see page 6-03.

# Series ICKN-55

## NAMUR

### Technical data

Model-no.:	ICKN-55-310	ICKN-55-311	ICKN-55-510	ICKN-55-511	ICKN-55-520	ICKN-55-530	ICKN-55-533
Operating pressure (bar)	3 ... 8	3 ... 8	3 ... 8	3 ... 8	2 ... 8	3 ... 8	3 ... 8
Pilot pressure (bar)	3 ... 8	3 ... 8	3 ... 8	3 ... 8	2 ... 8	3 ... 8	3 ... 8
Flow rate (NI/min)	780	780	900	800	900	680	680
Response time (ms) at 6 bar	on: 16 off: 18	on: 13 off: 16	on: 16 off: 17	on: 16 off: 18	on: 14 off: 14	on: 14 off: 16	on: 14 off: 16
Weight (kg)	0.320	0.320	0.320	0.320	0.440	0.440	0.440

### Dimensions

#### ICKN-55-31x-HN

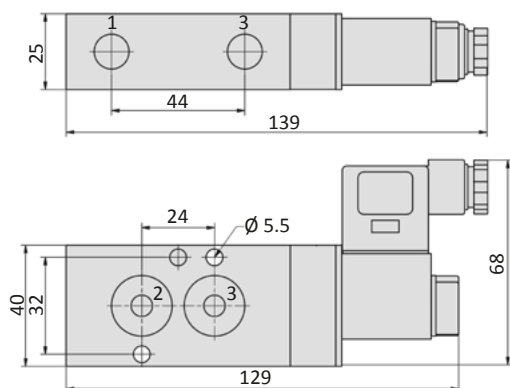

#### ICKN-55-51x-HN

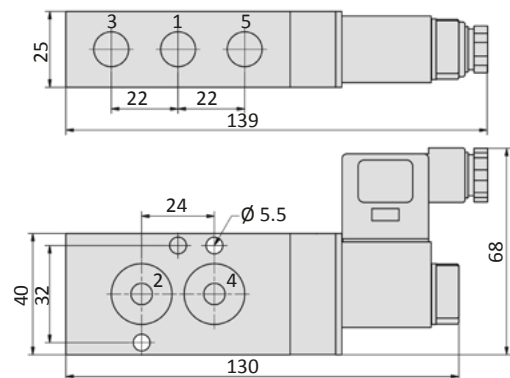

#### ICKN-55-520-HN, ICKN-55-53x-HN

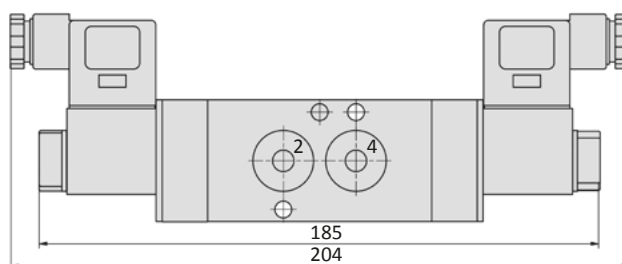

1 = pressure inlet  
2,4 = outlets  
3,5 = exhausts

Plug socket (not included in scope of delivery) can be repositioned by 180°.  
Solenoid coil can be repositioned.

### Accessories



Plug sockets: page 6-14

## Form B industrial norm

<b>Overall width</b>	22 mm
<b>Contact distance</b>	11 mm
<b>Contacts</b>	2P + E
<b>Protection</b>	IP 65 according to EN 60529 requires a flat gasket
<b>For use with series</b>	ICK-09, ICK-10, KMX-09, KMX-10, ICKN-55, KNX-55



<b>Model-no.:</b>	28-ST-01	28-ST-04-112	28-ST-04-127	28-ST-06-112	28-ST-06-127	28-ST-06-K3-112	28-ST-06-K3-127
<b>Voltage (AC/DC)</b>	0 - 250 V	10 - 50 V	70 - 250 V	24 V	230 V	24 V	230 V
<b>Status indicator</b>	no	yes	yes	yes	yes	yes	yes
<b>Protective circuit</b>	no	no	no	yes (Varistor)	yes (Varistor)	yes (Varistor)	yes (Varistor)
<b>Connecting cable</b>	without	without	without	without	without	3 m	3 m
<b>Wire cross section</b>	max. 1.5 mm <sup>2</sup>	max. 1.5 mm <sup>2</sup>	max. 1.5 mm <sup>2</sup>	max. 1.5 mm <sup>2</sup>	max. 1.5 mm <sup>2</sup>	3 x 0.75 mm <sup>2</sup>	3 x 0.75 mm <sup>2</sup>
<b>Ø Connecting cable</b>	6 - 8 mm	6 - 8 mm	6 - 8 mm	6 - 8 mm	6 - 8 mm		

## Dimensions

### Form B industrial norm

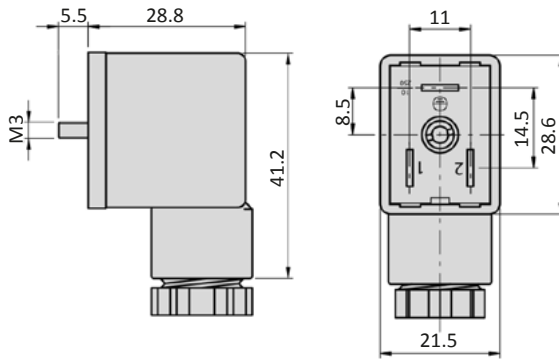

## Solenoid coils

### Form B industrial norm

Overall width	22 mm
Contact distance	11 mm
Contacts	2P + E
Protection	IP 65 according to EN 60529 with connected plug socket
Duty cycle	100 %
Temperature range*	-40°C ... +80°C
Voltage tolerance	± 10 %
For use with series	ICK-09, ICK-10, KMX-09, KMX-10, ICKN-55, KNX-55



\* The max. applicable operating temperature, depends on the temperature specification of the used valve.

Model-no.:	23-SP-060-1-712
Voltage	24 V DC
Power consumption DC	4.2 W
Power consumption AC	-

### Dimensions

#### Form B industrial norm

